

Activité 1 : l'orchestre de Polo

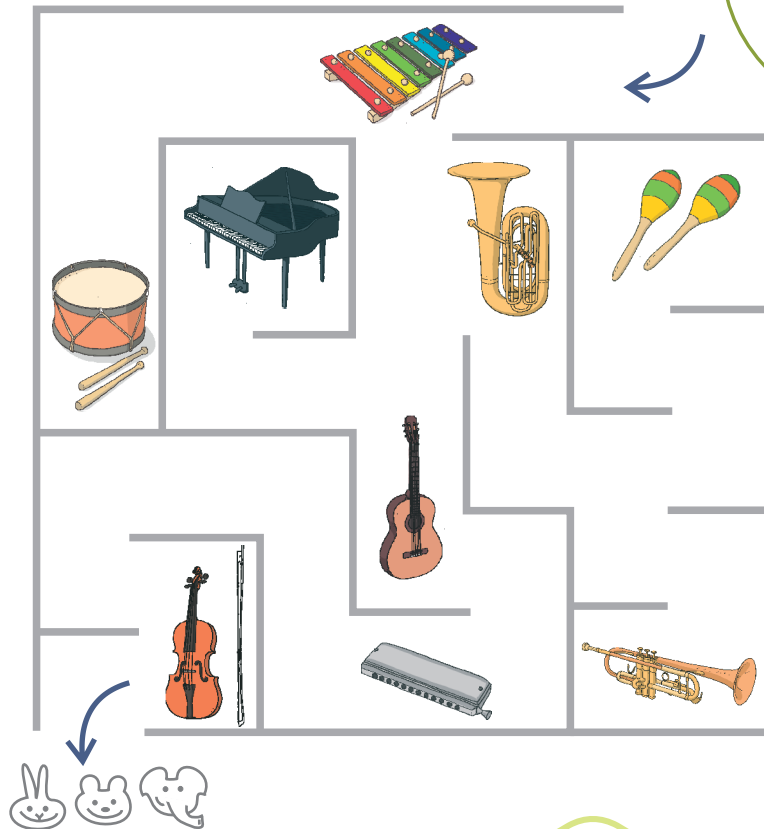

“ Aide moi à trouver le bon chemin pour rassembler les instruments et les apporter à mes amis...”

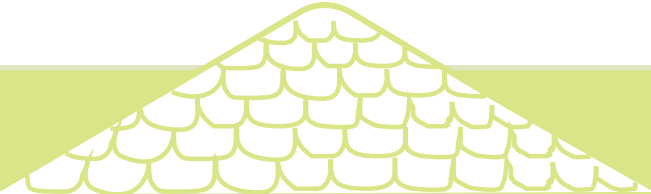

J'ai beaucoup aimé faire cette activité !



J'ai aimé faire cette activité !



J'ai moyennement aimé faire cette activité !



Je n'ai pas aimé faire cette activité !



Coche le lapin correspondant



Ca y est, en avant la musique ! Polo est devenu chef d'orchestre

Tous ses amis, c'est promis, il va les mener à la baguette

Première étape : mettre ses chaussettes

Ensuite, en cheminant

Il faudra récolter tous les instruments

Une **trompette**, une **guitare** , un **tambour**

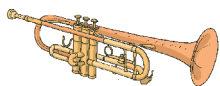

Jusque là ce n'est pas trop lourd

Un **harmonica**, des **maracas**, un **tuba**

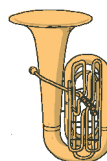
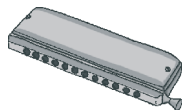

Polo n'en aura jamais assez avec ses deux bras pour porter tout ça

Un **piano**, un **xylophone** et un **violon**

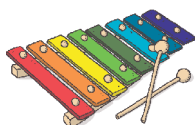

Alors là, c'est certain, Polo aura besoin d'un camion

Et s'il faut en plus une **batterie**, un **saxophone** et un **accordéon**



Il pensera même à mettre le tout dans un avion

“ Aide moi à trouver le bon chemin pour rassembler les instruments et les apporter à mes amis...”

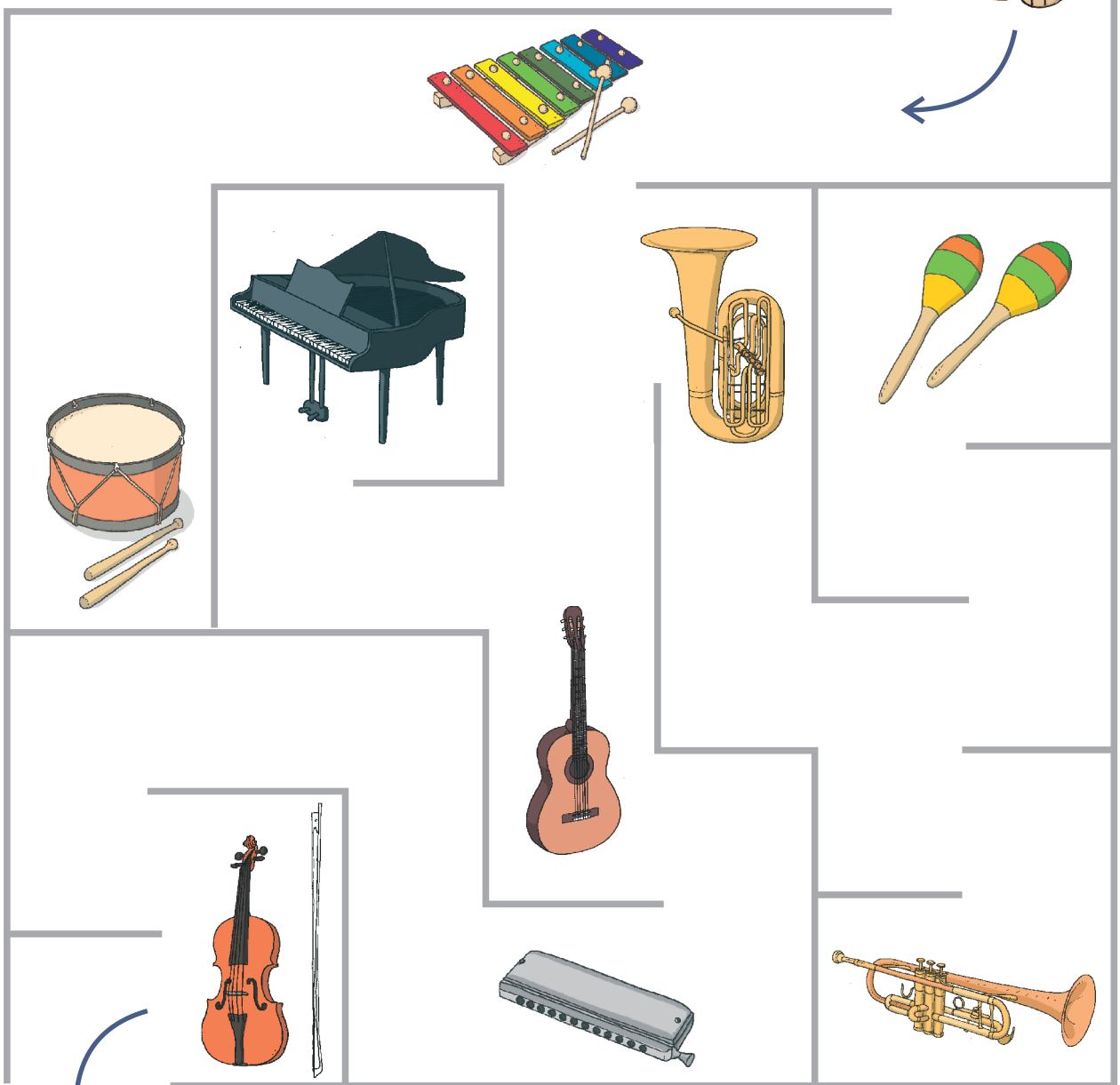

“ Voici les instruments
qui sont dans le labyrinthe...”



le piano

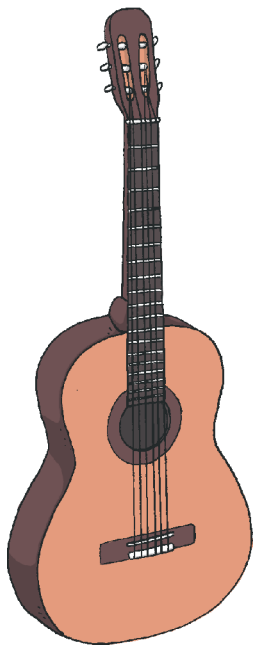

la guitare

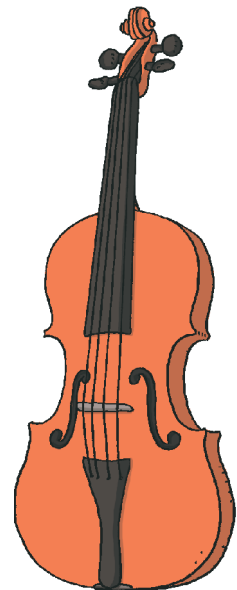

le violon

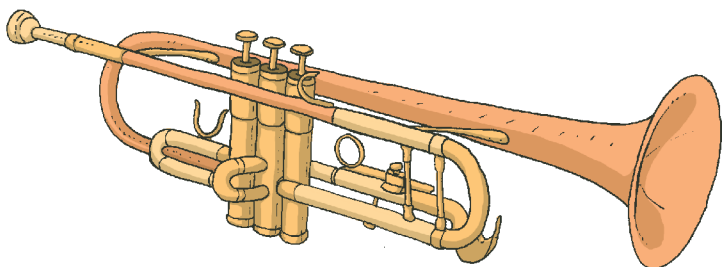

la trompette

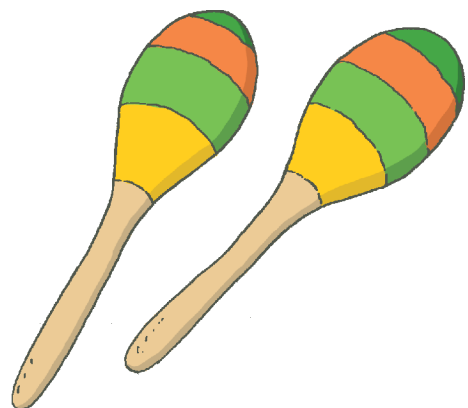

les maracas



le tambour

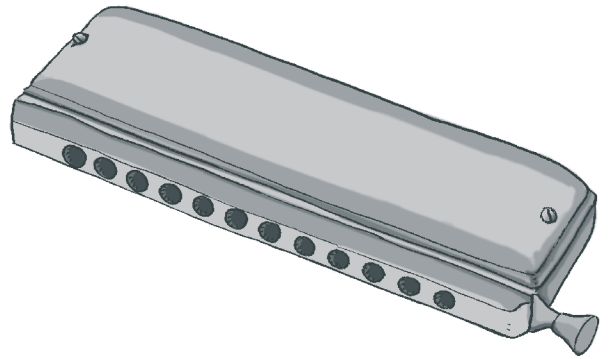

l'harmonica

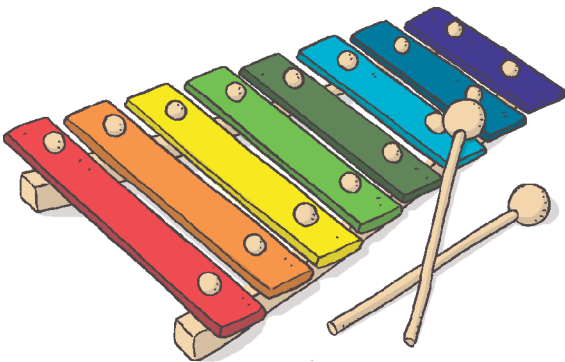

le xylophone

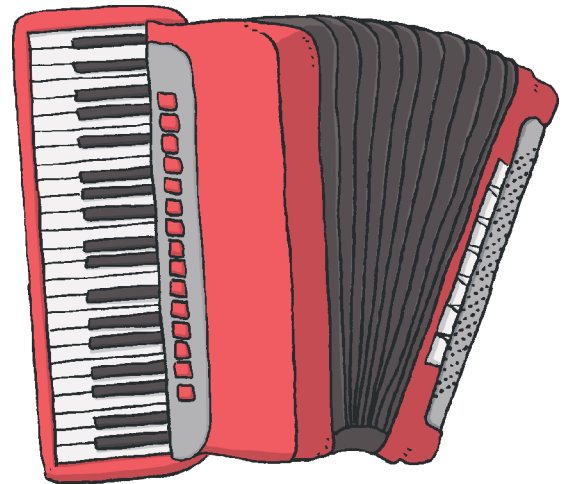

l'accordéon

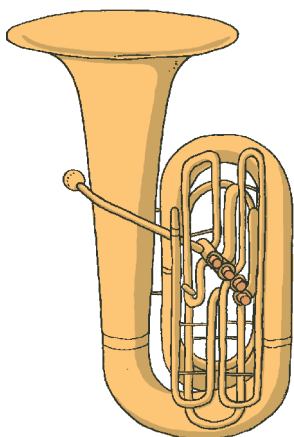

le tuba

“ un des instruments
n'est pas dans le labyrinthe,
as-tu repéré lequel ?...”



Activité 2 : frapper, souffler, frotter ?

Colorie en **rouge** les instruments sur lesquels Polo doit **frapper** pour faire de la musique

Colorie en **bleu** les instruments dans lesquels Polo doit **souffler** pour faire de la musique

Colorie en **jaune** les instruments que Polo doit **frotter** pour faire de la musique

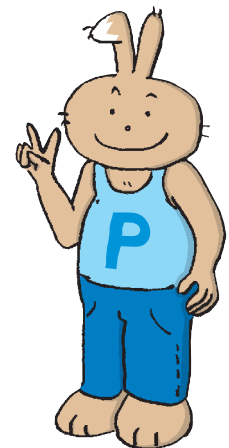

J'ai beaucoup aimé faire cette activité !



J'ai aimé faire cette activité !



J'ai moyennement aimé faire cette activité !



Je n'ai pas aimé faire cette activité !



Coche le lapin correspondant



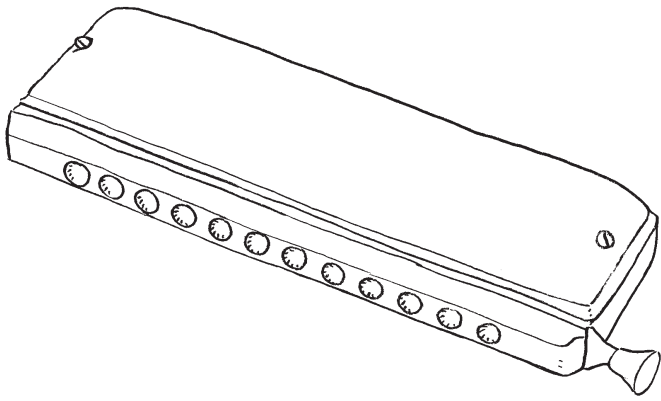

l'harmonica (souffler)

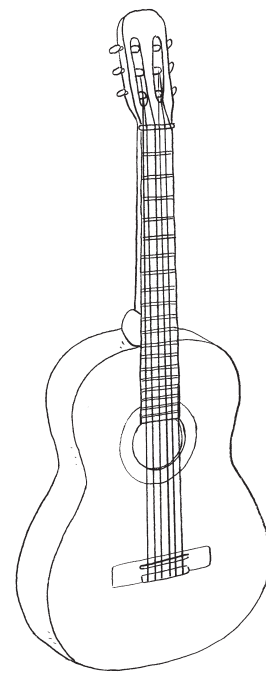

la guitare
(frotter)

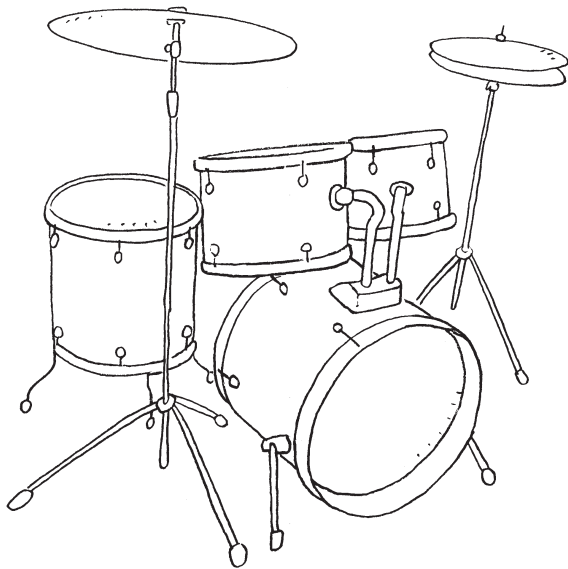

la batterie (frapper)

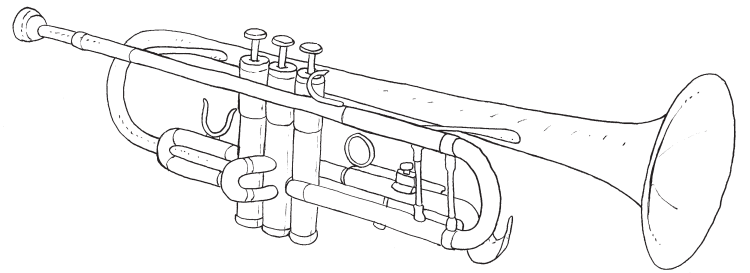

la trompette (souffler)

le violon
(frotter)

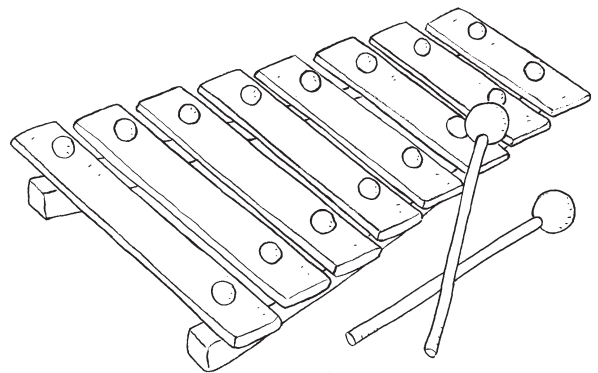
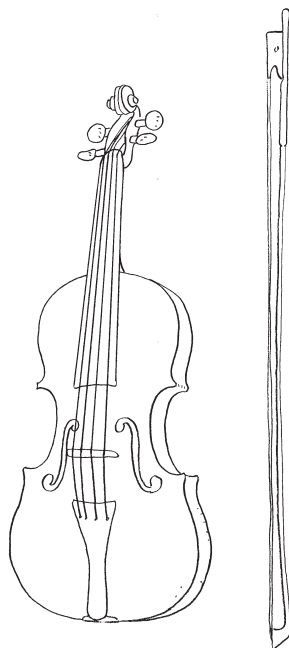

le xylophone (frapper)

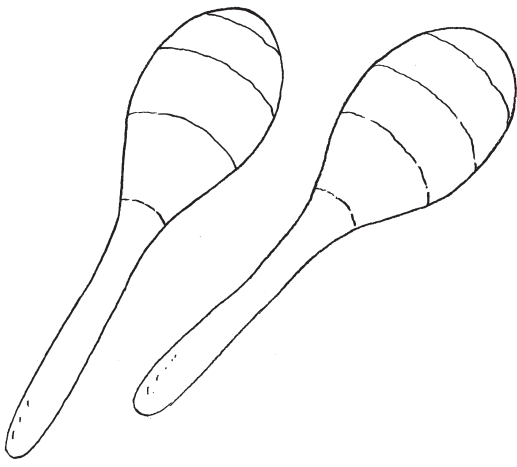

les maracas (frapper)

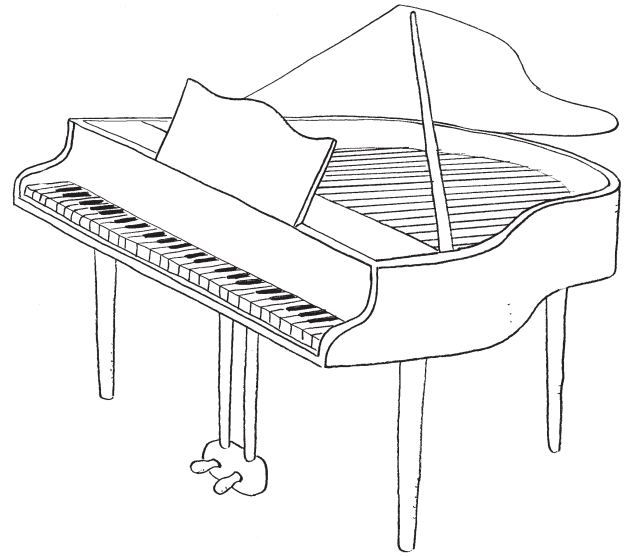

le piano (frapper)

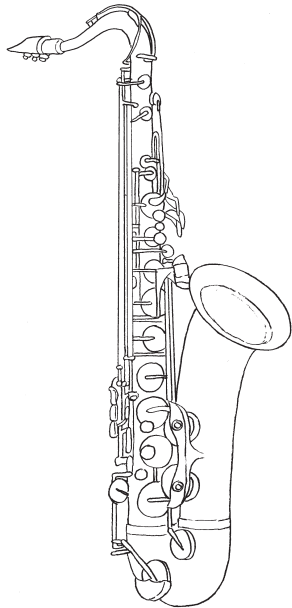

le saxophone (souffler)

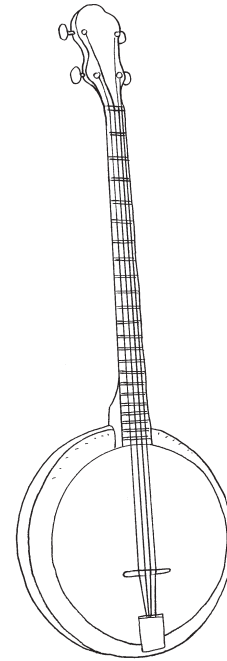

le banjo
(frotter)

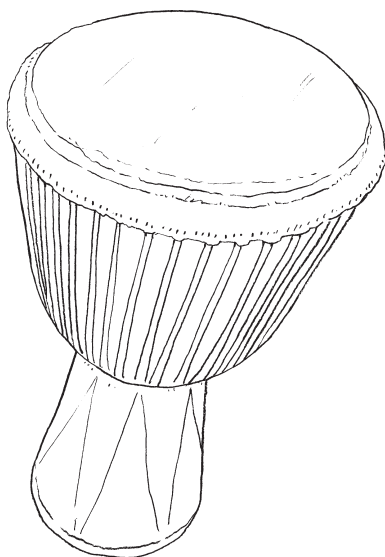

le tam-tam (frapper)

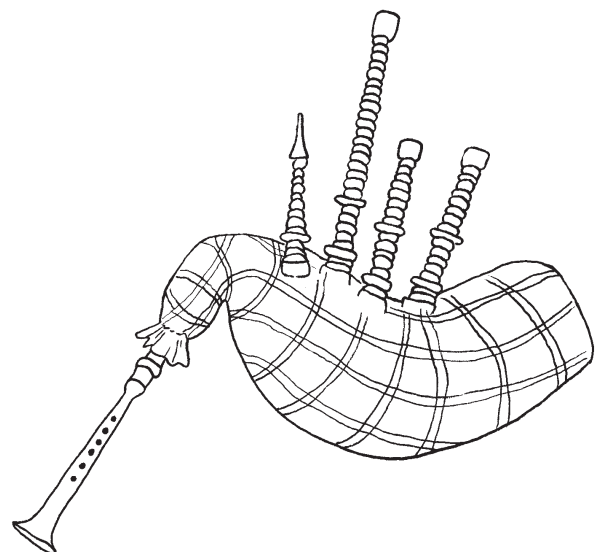

la cornemuse (souffler)

Activité 3 : Ca va ou ça ne va pas ?

“ Est-ce que ça va
ou ça ne vas pas ? “



Polo a mis sur sa tête un grand chapeau

Polo a mis sur sa tête un grand château

Polo a mis sur sa tête un grand bateau

Polo habite dans un beau château

Polo habite dans un beau chapeau

Pour voguer sur l'eau, Polo est dans un joli bateau

Pour voguer sur l'eau, Polo est dans un joli château

Pour jardiner Polo utilise un râteau

Pour jardiner Polo utilise un château

J'ai beaucoup aimé faire cette activité !



J'ai aimé faire cette activité !



J'ai moyennement aimé faire cette activité !



Je n'ai pas aimé faire cette activité !



Coche le lapin
correspondant



Activité 4 : la musique des animaux

“ relie chaque animal
à son cri “



Houa houa (aboyer)



Bèè bèè (bêler)

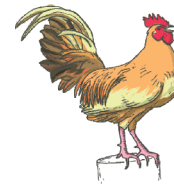

Cocoricoo (chanter)

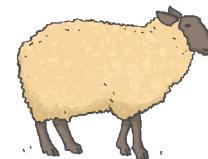

J'ai beaucoup aimé faire cette activité !



J'ai aimé faire cette activité !



J'ai moyennement aimé faire cette activité !



Je n'ai pas aimé faire cette activité !



Coche le lapin
correspondant



► **Fiches parents.** Fiche 4b. La musique des animaux

“ relie chaque animal
à son cri “



Miaou (miauler)

Meuh meuh (meugler)

Houa houa (aboyer)

Bèè bèè (bêler)

Cocoricoo (chanter)

Hi-han hi-han (braire)

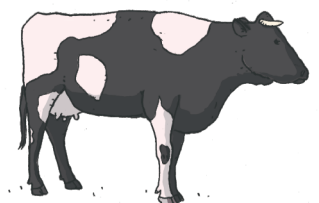
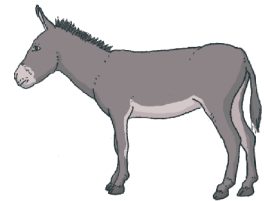
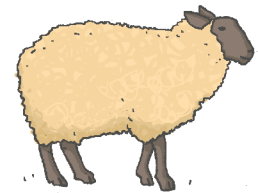
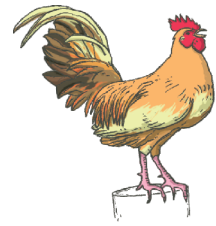
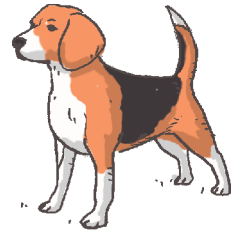

Activité 5 : la comptine en italien

“ Demande à papa ou maman
de lire la comptine ci-dessous
et écoute la musique
des mots... “



Clic cloc cavallotto
l'asinello va di trotto
passa monti, passa valli,
Matildina sui cavalli.
Il cavallo si volta indietro
Matildina giù da dietro !

J'ai beaucoup aimé faire cette activité !



J'ai aimé faire cette activité !



J'ai moyennement aimé faire cette activité !



Je n'ai pas aimé faire cette activité !



Coche le lapin
correspondant

